

Cannulated Screws

3.0/3.5/4.0/4.5/6.5/7.0/7.3

Surgical technique

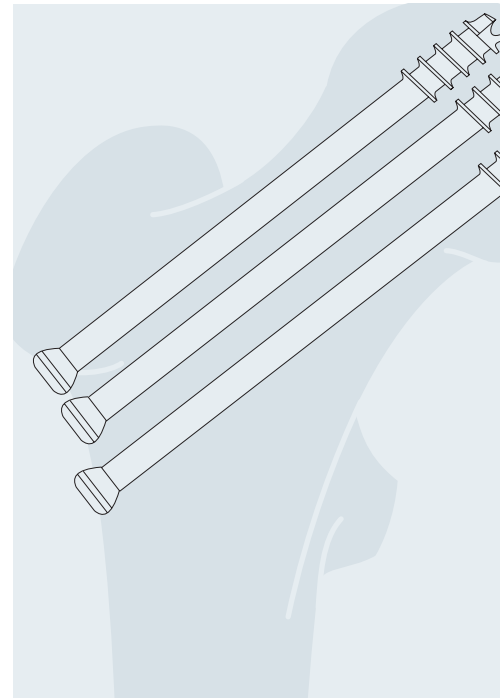
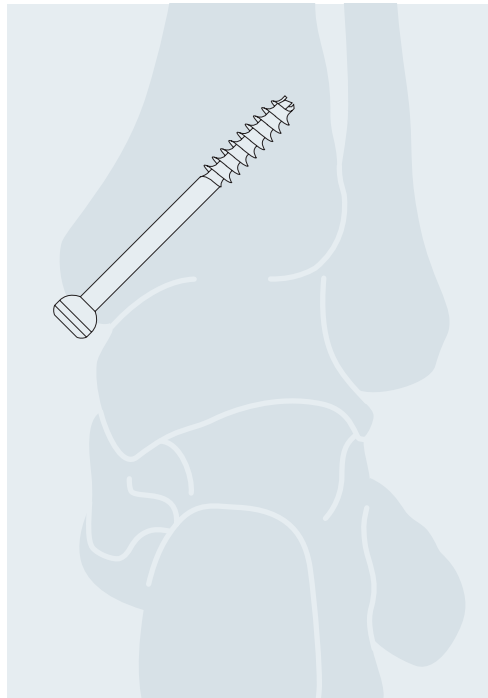
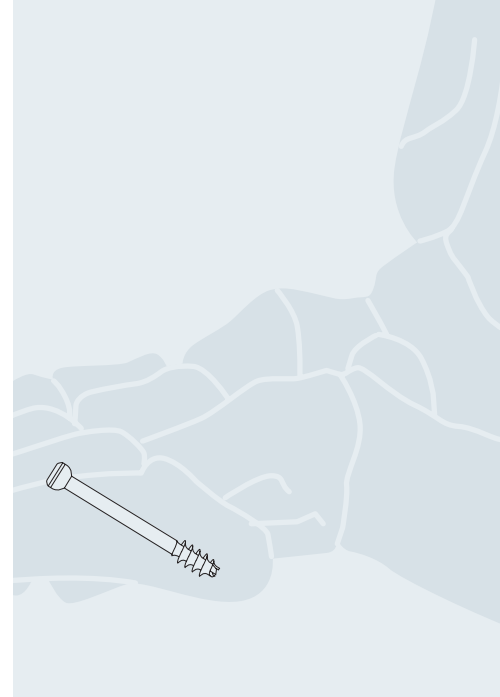
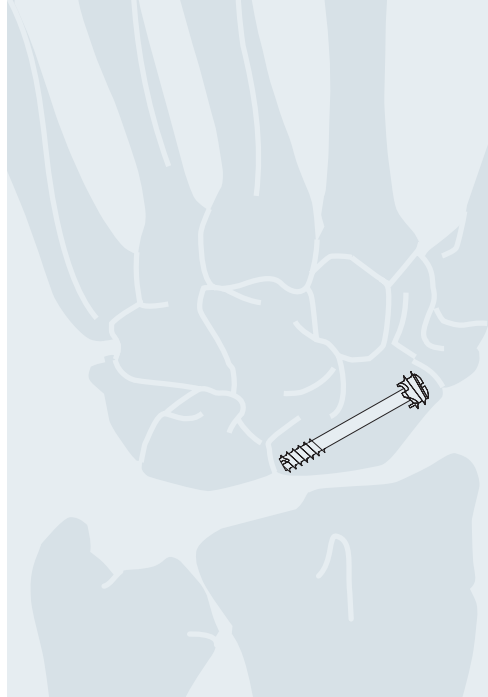

Table of contents

Indications	2
Implants	4
Surgical technique	
All cannulated screws (illustrated using the cannulated screw 4.5)	6
Cannulated screw 3.0 with support screw	11
Open insertion for cannulated screw 6.5/7.3	14
Implant removal	15
Instrument cleaning	16

 Image intensifier control

Warning

This description is not sufficient for immediate application of the instrumentation. Instruction by a surgeon experienced in handling this instrumentation is highly recommended.

Indications

CSS 3.0

Fixation of fractures of the forearm, hand and foot, e.g.:

- fractures and arthrodeses of the carpals and metacarpals
- fractures of the distal radius and radial head
- metatarsal fractures

CSS 3.5

Fixation of fractures with small fragments, e.g.:

- wrist fractures
- metacarpal and metatarsal fractures and fixation in metacarpal and metatarsal osteotomies
- tarsal fractures
- transcondylar humeral fractures in children

CSS 4.0

Fixation of fractures with medium fragments, e.g.:

- tarsal and metatarsal fractures and fixation in metatarsal and phalangeal osteotomies
- tarsometatarsal and metatarsophalangeal arthrodeses
- ligament fixations
- hallux valgus corrections

CSS 4.5

Fixation of fractures with medium fragments, e.g.:

- malleolar fractures
- pilon tibial fractures
- fractures of the calcaneus and talus
- tibial plateau fractures
- carpal and tarsal arthrodeses

CSS 6.5, 7.0 und 7.3

Fixation of fractures with large fragments, e.g.:

- femoral neck fractures
- intercondylar femoral fractures
- epiphyseolysis of the femoral head
- ankle arthrodeses
- iliosacral dislocations

Fields of application

Adults

Use correspondingly smaller screws for children, adolescents and adults of small stature.

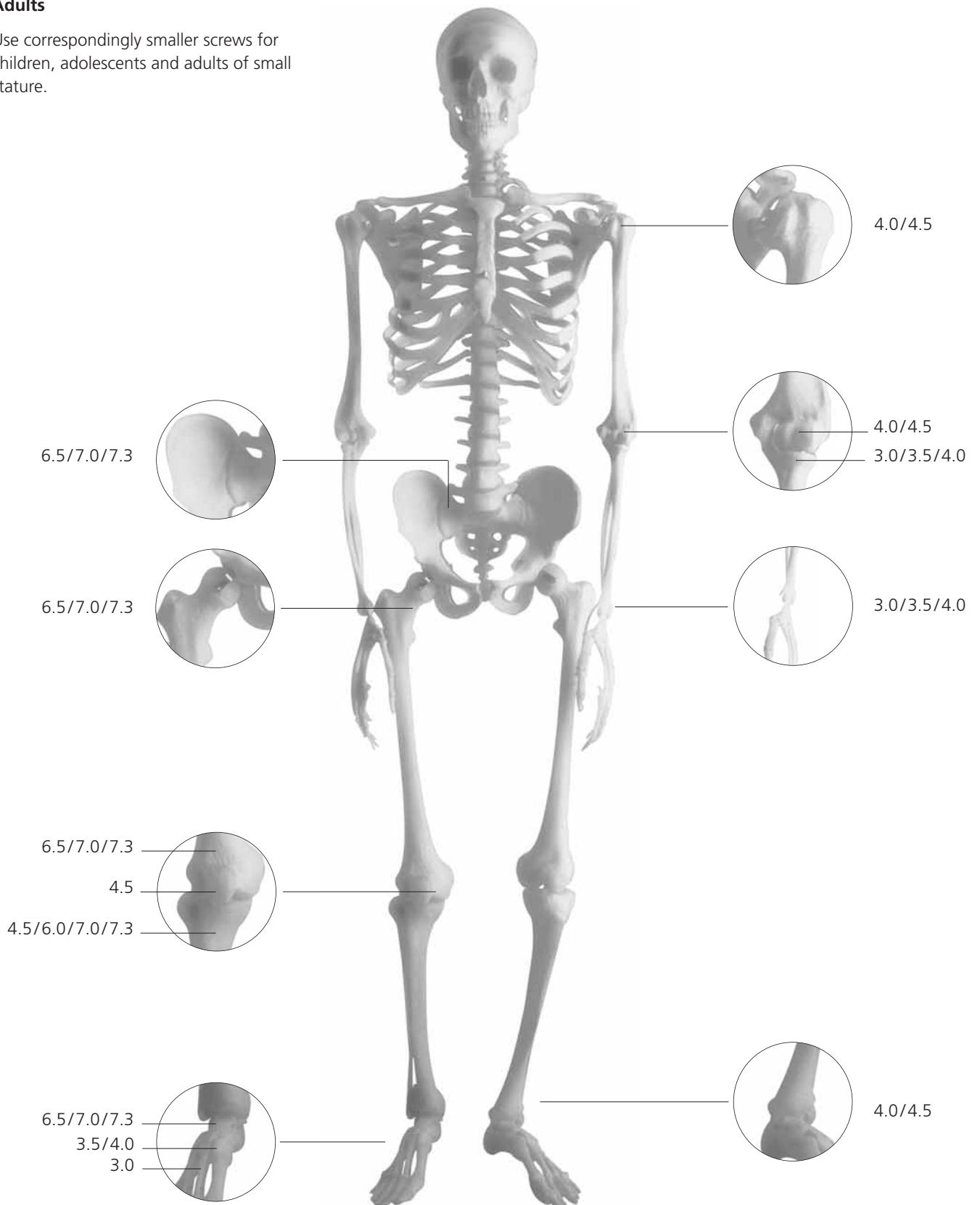

Implants

The implants are available in stainless steel and titanium.
To obtain the complete article number, replace "X" with
"2" for stainless steel or "4" for titanium.

Cannulated Screws

Short thread



Long thread



Full thread



Cannulated Screws	Recess*	Art. no. short thread	Thread			External dia- meter	Shaft dia- meter	Length
			long thread	full thread				
3.0 self-drilling	4.0 mm cruciform	X02.608–650	X02.714–749	–	3.0 mm	2.0 mm	8– 50 mm	
3.5 self-drilling	2.5 mm Hex	X05.110–150	–	X05.310–350	3.5 mm	2.4 mm	10– 50 mm	
3.5 self-tapping	2.5 mm Hex	205.010–050	–	205.210–250	3.5 mm	2.5 mm	10– 50 mm	
4.0 self-drilling	2.5 mm Hex	X07.610–672	X07.716–772	–	4.0 mm	2.6 mm	10– 72 mm	
4.5 self-drilling	3.5 mm Hex	X14.520–580	–	X14.720–777	4.5 mm	3.1 mm	20– 80 mm	
4.5 self-tapping	3.5 mm Hex	214.420–472	–	214.620–672	4.5 mm	3.1 mm	20– 72 mm	
6.5 self-drilling	4.0 mm Hex	X08.401–425	X08.431–452	X08.460–482	6.5 mm	4.8 mm	20–150 mm	
7.0 self-drilling	3.5 mm Hex	X08.151–171	X08.174–191	X08.201–223	7.0 mm	4.5 mm	20–130 mm	
7.0 self-tapping	3.5 mm Hex	208.030–130	209.045–130	209.420–530	7.0 mm	4.5 mm	20–130 mm	
7.3 self-drilling	4.0 mm Hex	X08.830–950	X09.845.950	X09.620–730	7.3 mm	4.8 mm	20–150 mm	

All cannulated screws have reverse-cutting flutes, allowing easy
removal of even firmly embedded screws.

* cruciform



Hex



Guide wires



Cannulated Screw	Guide Wire Art. no.	Diameter	Length	Tip
3.0	292.622 / 292.623	1.1 mm	150 mm	Threaded tip with/or triangular trocar
3.5	292.620	1.25 mm	150 mm	Threaded tip with rectangular trocar
4.0	292.620	1.25 mm	150 mm	Threaded tip with rectangular trocar
4.5	292.720	1.6 mm	150 mm	Threaded tip with rectangular trocar
7.0	292.650	2.0 mm	230 mm	Threaded tip with rectangular trocar
6.5/7.3	292.680	2.8 mm	300 mm	Threaded tip with triangular trocar
	292.810	2.8 mm	300 mm	Drill bit

Washers

All cannulated screws can be used with or without a washer (or support screw for the cannulated screw 3.0).



Cannulated Screw	Washer Art. no.	Outside diameter	Internal diameter
3.0	X19.972	6.5 mm	3.3 mm
3.5	X19.980	7.0 mm	3.6 mm
4.0	X19.980	7.0 mm	3.6 mm
4.5	X19.910	10.0 mm	4.6 mm
7.0	X19.990	13.0 mm	6.6 mm
6.5/7.3	X19.990	13.0 mm	6.6 mm

Washer, spherical

Prevents projection of the screw head, when the screw must be inserted at an acute angle.

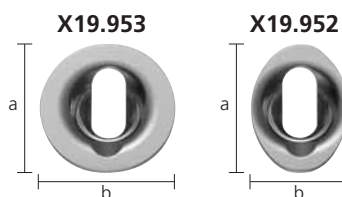

Cannulated Screw	Washer Art. no.	Height (a)	Width (b)	Depth
6.5/7.0/7.3	X19.952	22 mm	16 mm	6.1 mm
6.5/7.0/7.3	X19.953	22 mm	22 mm	6.1 mm

Support Screw for Cannulated Screw 3.0

Self-drilling, outside diameter 5.5 mm, core diameter 4.25 mm, length 3 mm, with cannulation and hexagonal socket 3.2 mm (219.890. 419.890)



Surgical technique for all cannulated screws

The following surgical technique is explained using the example of a malleolar fracture.

1

Reduce fracture and insert guide wire

After a stab incision, advance the drill sleeve or drill sleeve assembly through the soft tissues to the bone. Insert the guide wire through the drill sleeve to the desired depth and position.

Remove the drill sleeve and check the position of the guide wire under the image intensifier.

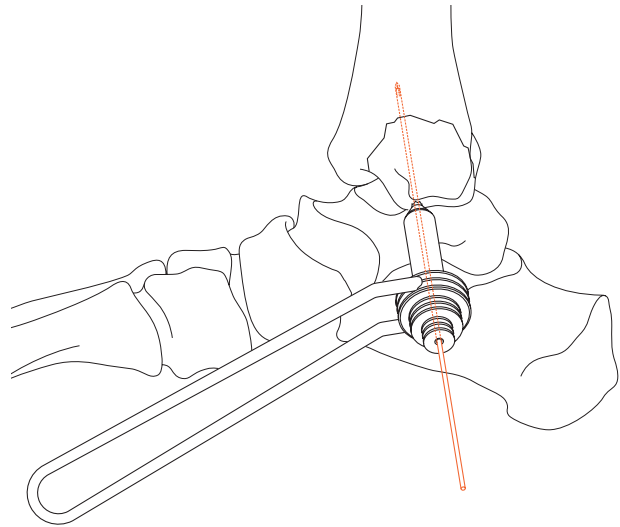

Required instruments

Cannulated Screw	Guide Wire	Drill Sleeve
3.0	Ø 1.1 mm (292.622/292.623)	Double Drill Sleeve 2.0/1.1 (312.151)
3.5	Ø 1.25 mm (292.620)	Double Drill Sleeve 2.7/1.25 (312.350)
4.0	Ø 1.25 mm (292.620)	Double Drill Sleeve 2.7/1.25 (312.350)
4.5	Ø 1.6 mm (292.720)	Percutaneous Drill Sleeve Assembly: – Protection Sleeve 9.5/7.0 (312.770) – Drill Sleeve 7.0/3.2 (312.760) – Drill Sleeve 3.2/1.6 (312.750) – Trocar Ø 1.6 mm (312.740)
7.0	Ø 2.0 mm (292.650)	Percutaneous Drill Sleeve Assembly: – Protection Sleeve 11.0/8.0 (319.340) – Drill Sleeve 8.0/4.5 (319.330) – Drill Sleeve 4.5/2.0 (319.320) – Trocar Ø 2.0 mm (319.310)
6.5/7.3	Ø 2.8 mm (292.680, 292.810/900.726)	Drill Sleeve Assembly: – Protection Sleeve 12.0/8.5 (312.050) – Drill Sleeve 8.5/2.8 (312.080) – Trocar Ø 2.8 mm (312.020)

2

Option: Insert guide wires in parallel (only for cannulated screws 4.5/6.5/7.0/7.3)

Slide the non-adjustable guide sleeve (1) of the parallel guide over the already inserted guide wire. Move the (adjustable) guide sleeve (2) to the desired position and tighten the nut. Insert the second guide wire.

Insert the desired number of parallel guide wires as described and remove the parallel guide.

Note: The placement of three guide wires is recommended to achieve good rotational stability.

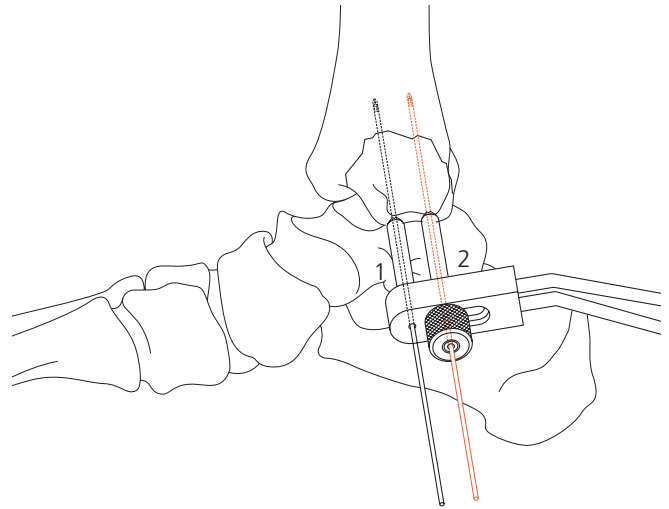

Required instruments

Cannulated Screw	Parallel Guide for Guide Wires
4.5	adjustable (312.730)
7.0	– non-adjustable (312.710) – for percutaneous insertion (319.300)
7.3	– adjustable (312.010) – for open insertion (312.070); see the section on “Open insertion for cannulated screw 7.3” – for percutaneous insertion (312.692)

3

Option: Drilling

For self-tapping screws (see page 4), the desired length must be predrilled with the cannulated drill bit. Predrilling the near cortex is also recommended for hard bones when using the self-drilling screws.

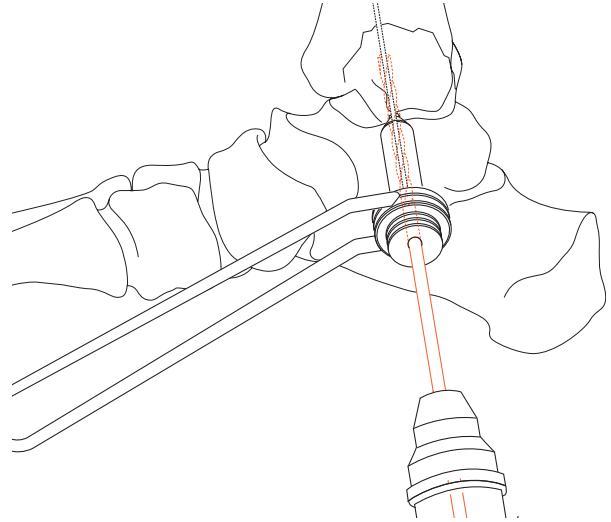

Required instruments

Cannulated Screw	Drill Bit, cannulated
3.0	∅ 2.0 mm (310.221)
3.5	∅ 2.7 mm (310.670)
4.0	∅ 2.7 mm (310.670)
4.5	∅ 3.2 mm (310.650)
7.0	∅ 4.5 mm (315.690)
6.5/7.3	∅ 5.0 mm (310.630)

4

Option: Countersinking

Where the bone is surrounded by only a thin layer of soft tissue, the screw head may be countersunk using the cannulated countersink to prevent projection of the screw head. Countersinking also facilitates screw insertion.

Note: If the countersink fails to bite, the near cortex can be predrilled using the cannulated drill bit.

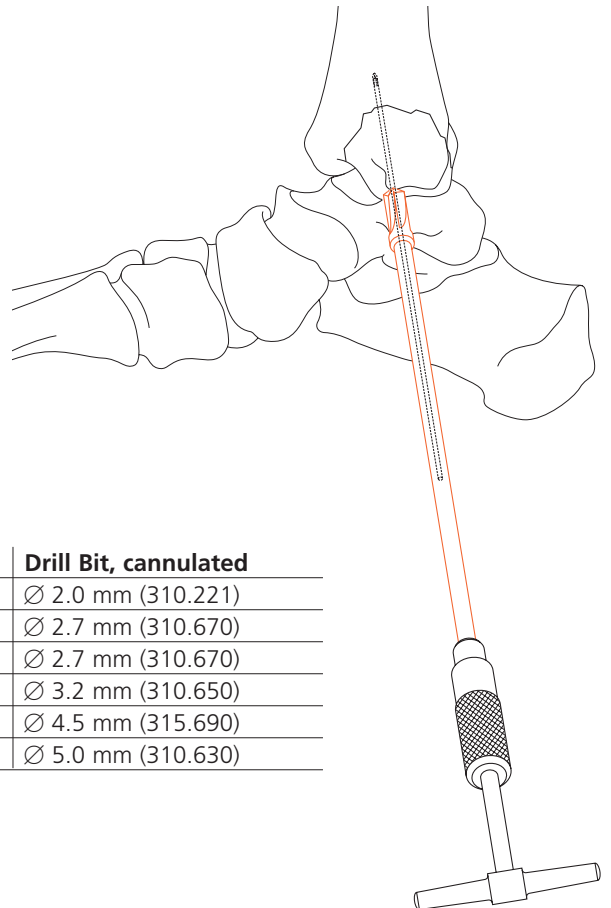

Required instruments

Cannulated Screw	Countersink, cannulated	Drill Bit, cannulated
3.0	310.804	∅ 2.0 mm (310.221)
3.5	310.860	∅ 2.7 mm (310.670)
4.0	310.860	∅ 2.7 mm (310.670)
4.5	310.850	∅ 3.2 mm (310.650)
7.0	310.790	∅ 4.5 mm (315.690)
6.5/7.3	310.780	∅ 5.0 mm (310.630)

5

Determine screw length

Cannulated screw 3.0/3.5/4.0

Advance the direct measuring device for cannulated screws down to the cortical bone. Read off the appropriate screw length directly on the scale.

Cannulated screw 4.5/6.5/7.0/7.3

Insert the protection sleeve and slide the direct measuring device over the guide wire. Read off the appropriate screw length directly on the scale.

Note: Only use the guide wire in its original length to ensure correct measurement.

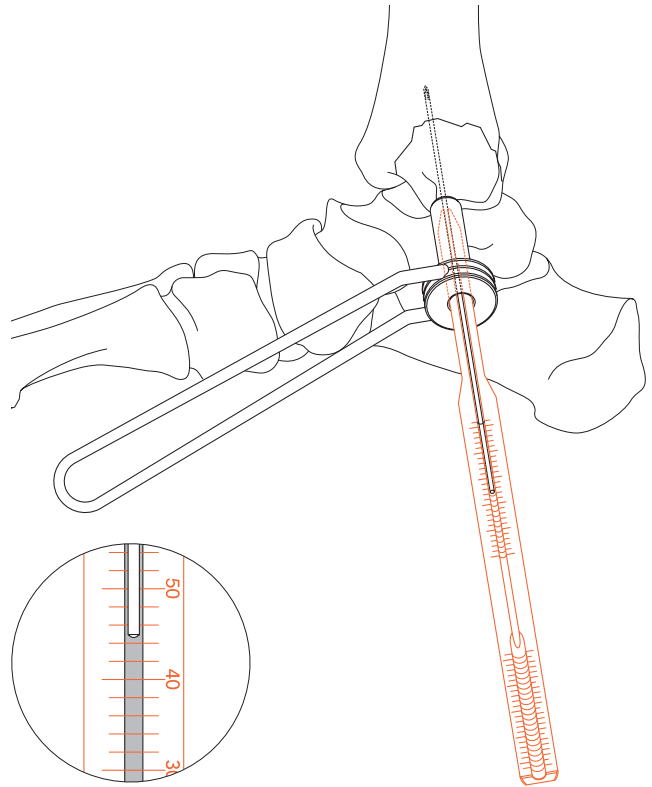

Required instruments

Cannulated Screw	Direct Measuring Device	Protection Sleeve
3.0	319.702	–
3.5	319.150	–
4.0	319.150	–
4.5	319.170	312.770
7.0	319.210	319.340
6.5/7.3	319.700	312.050

6

Insert screw

Insert the appropriate cannulated screw using the cannulated screwdriver and the holding sleeve.

Cannulated screw 4.5/6.5/7.0/7.3

Insert the appropriate cannulated screw through the protection sleeve using the hexagonal cannulated screwdriver. Next, remove the protection sleeve.



Remove and dispose of the guide wire. Check the final position of the screw under the image intensifier.

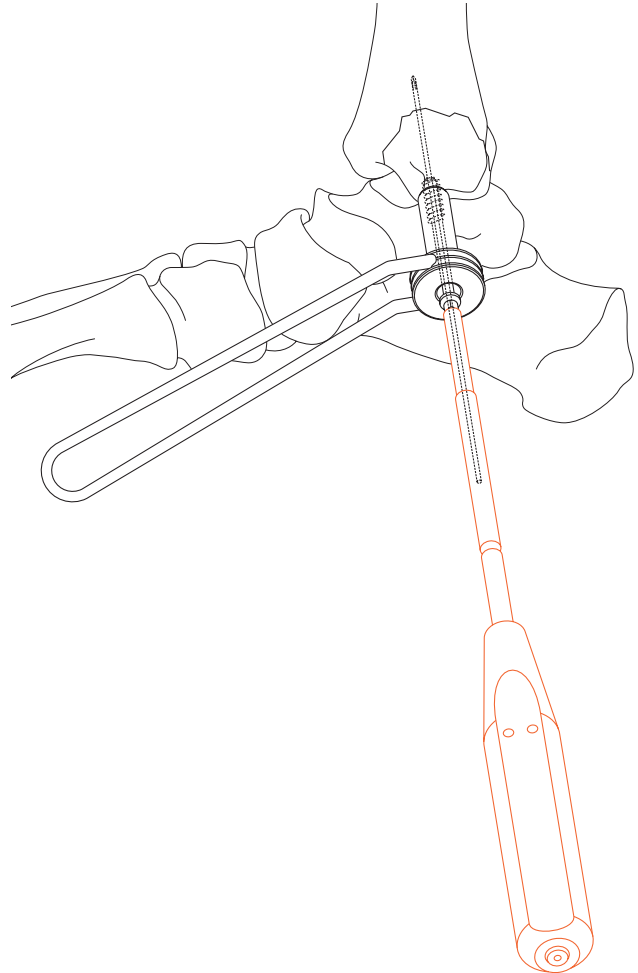

Required instruments

Cannulated Screw	Screwdriver, cannulated	Washer	Holding Sleeve	Protection Sleeve
3.0	Cruciform screwdriver (314.463)	X19.972*	313.969	–
3.5	Hexagonal screwdriver (314.290)	X19.980*	314.080 or 314.060	–
4.0	Hexagonal screwdriver (314.290)	X19.980*	314.080 or 314.060	–
4.5	Hexagonal screwdriver (314.200)	X19.910*	–	∅ 9.5/7.0 mm (312.770)
7.0	Hexagonal screwdriver (314.190)	X19.990*	–	∅ 11.5/7.0 mm (319.340)
6.5/7.3	Hexagonal screwdriver (314.050)	X19.990*	–	∅ 12.5/7.0 mm (312.770)

The implants are available in stainless steel and titanium.
To obtain the complete article number, replace "X" with "2"
for stainless steel and with "4" for titanium.

Procedure for osteoporotic bones:

In osteoporotic bone, the screw head can be prevented from sinking into the bone by using a washer (or spherical washer). Avoid tightening the screw tightly, because otherwise the thread may strip and the screw's grip in the bone could be compromised.

Note: The spherical washer prevents projection of the screw head, when the screw must be inserted at an acute angle (e.g., in ankle arthrodesis). The screw (6.5/7.0/7.3) can be inserted at an angle of 0–70°.

It is recommended that the Ø 13.0 mm Drill Bit (351.270) and the Ø 17.0/15.0 mm Protection Sleeve (357.530) be used as the double drill sleeve for the spherical washer.

Additional instruments required for use of the spherical washer

Cannulated Screw	Drill Bit, cannulated	Washer	Protection Sleeve
7.0	Ø 13.0 mm (351.270)	X19.952* or X19.953*	Ø 17.0/15.0 mm (357.530)
6.5/7.3	Ø 13.0 mm (351.270)	X19.980* or X19.953*	

The implants are available in stainless steel and titanium. To obtain the complete article number, replace "X" with "2" for stainless steel and with "4" for titanium.

Surgical technique for cannulated screw 3.0 with support screw

Application methods

- Intra-articular
With countersunk support screw
- Extra-articular
With cannulated screw technique
- Extra-articular in cases of poor bone quality
With washer

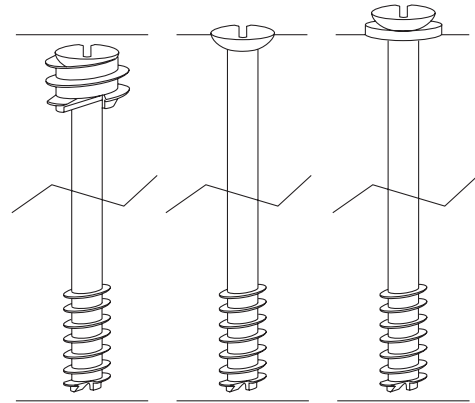

Functional characteristics

The support screw is anchored in cancellous bone by its thread. It supports the countersunk head of the cannulated screw in cancellous bone.

Reduction and compression of the fracture is achieved by inserting the cannulated screw.

Precise compression adjustment.

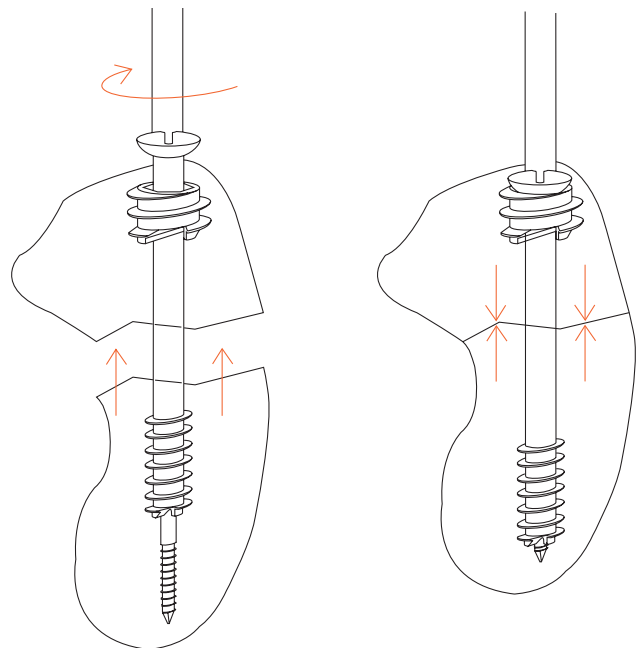

The following surgical technique uses a scaphoid bone fracture as an example. The use of a support screw is generally recommended for scaphoid bone fractures, with the exception of small proximal pole fractures. With the use of a support screw, the screw head can be countersunk, thus reducing the risk of postoperative articular restrictions in the range of motion.

1

Reduce fracture and insert guide wire

After the incision, temporarily reduce dislocated fragments with a Kirschner wire. Insert the Guide Wire \varnothing 1.1 mm with Threaded Tip (292.622) through the drill sleeve 1.1 of the Double Drill Sleeve 2.0/1.1 (312.151) and advance it into the bone from distal/lateral to proximal/medial until the threaded tip is anchored in the far cortex.

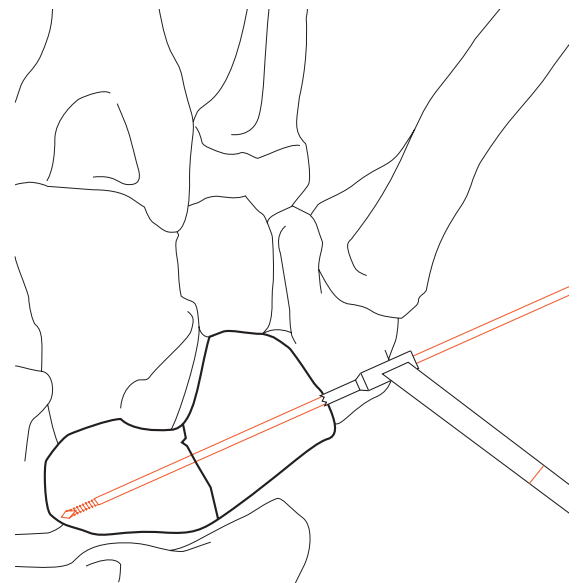
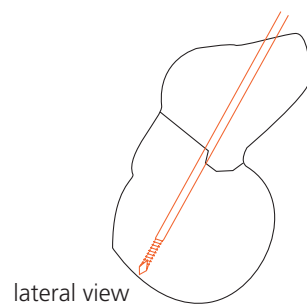

2

Option: Predrilling

Predrilling can be advantageous in dense bone as it reduces torque during screw insertion. Slide the Double Drill Sleeve 2.0/1.1 (312.151) with the Cannulated Drill Bit \varnothing 2.0 mm (310.221) over the guide wire and drill through the near cortex. Slowly and carefully, while running the drill forward, withdraw the drill bit to ensure the guide wire stays in place.

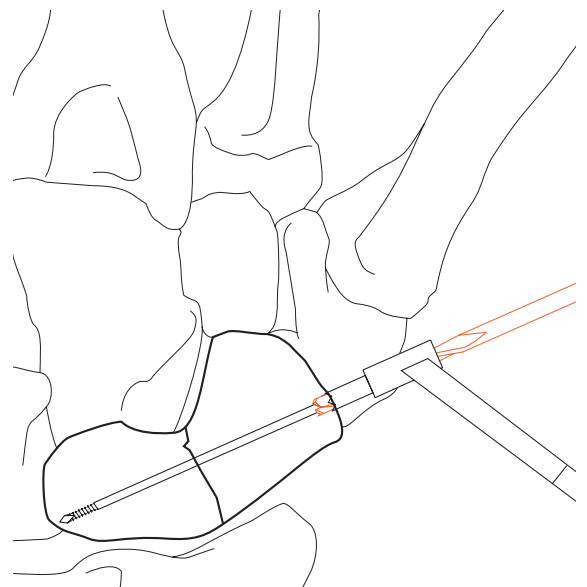

3

Ream the seat of the support screw

Slide the Double Drill Sleeve 5.5/4.3 (312.153) with the Cannulated Countersink (310.804) over the guide wire and ream to a depth of 5 mm. The reaming depth is indicated on the scale of the countersink.

The use of a drill is recommended, as reaming will be more precise than if performed manually.

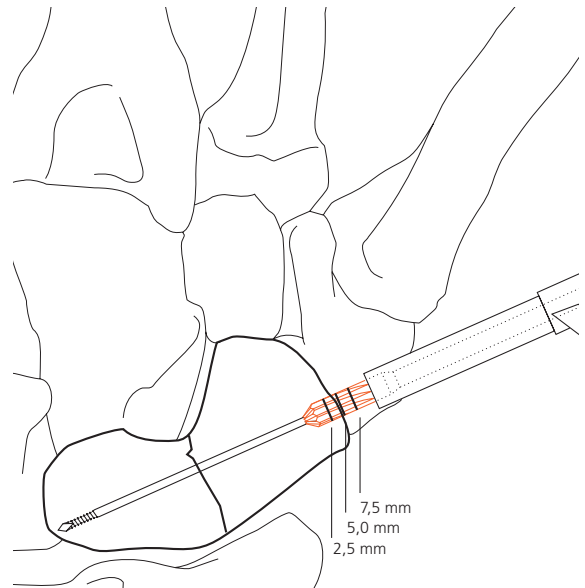

4

Insert the support screw

Insert the support screw 3 to 4 mm under the bone surface using the cannulated hexagonal screwdriver (Cannulated Hexagonal Screwdriver Shaft 314.464 and Handle 311.430). Thus, the head of the cannulated screw, buttressed by the support screw, will be fully countersunk.

Note: Make sure the shortest distance between the support screw and the bone surface is approximately 3 mm.

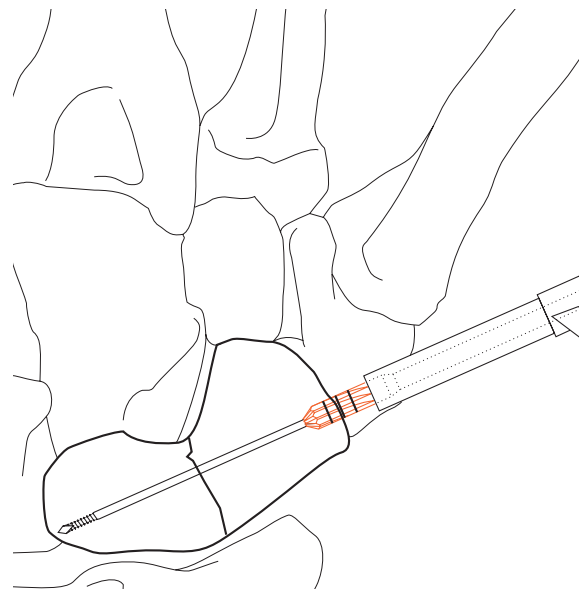

5

Determine screw length

Slide the Direct Measuring Device for Cannulated Screws \varnothing 3.0 mm (319.702) onto the guide wire and position it on the support screw. The required screw length is indicated directly on the measuring device.

Note: Do not introduce the measuring device into the support screw. The length has to be measured at the surface of the screw head, or else the screw will be 3–5 mm shorter than the guide wire.

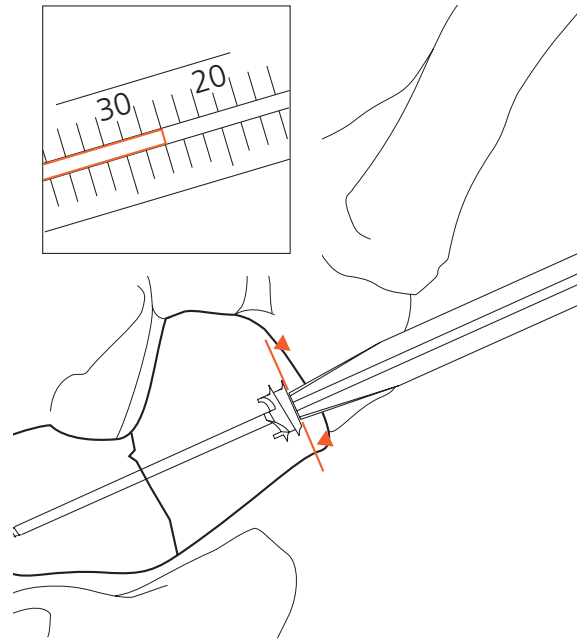

6

Insert the cannulated screw

Insert the selected cannulated screw using the Cruciform Cannulated Screwdriver (314.463) with Holding Sleeve (313.969). When tightening the screw, the fracture can be reduced precisely and compression can be performed in a controlled way.

Remove and dispose of the guide wire. Check the final position of the screw under the image intensifier.

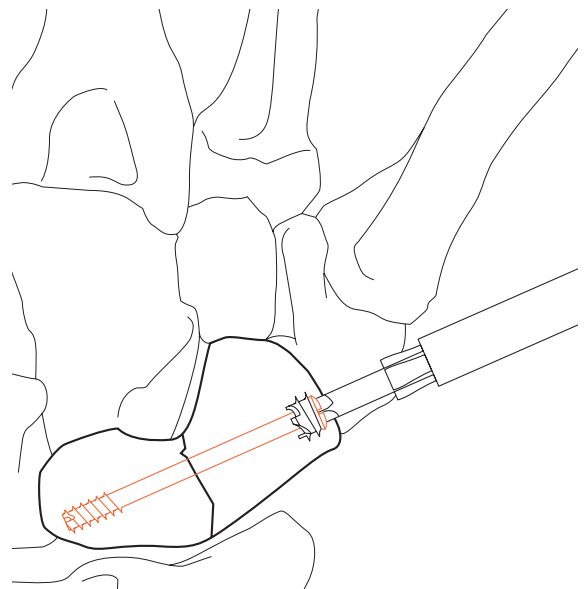

Open insertion for cannulated screw 6.5/7.3

1

Reduce fracture and make incision

Reduce the fracture and make an incision of approx. 5 cm.

2

Set angle of the wire guide

Use the Parallel Guide for Guide Wires with Adjustable Angles (312.070) to insert several parallel guide wires at a selected angle to the bone.

Set the desired angle (markings of 125°, 130°, 135° and 140°) on the wire guide and position the wire guide on the bone.

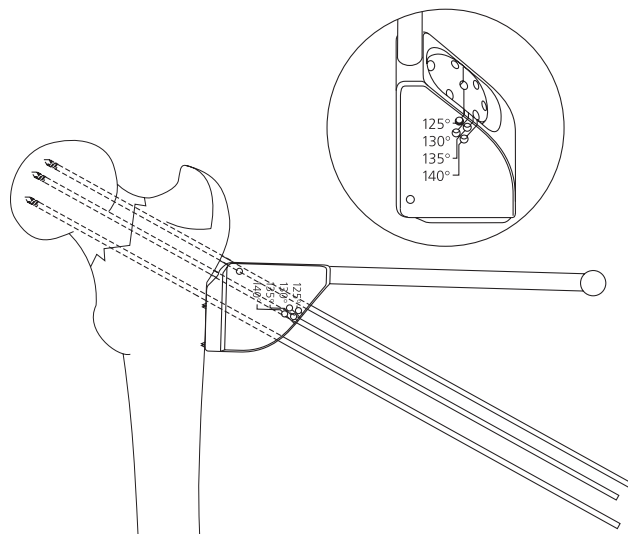

3

Select position of the parallel guide wires

- a Pattern of holes on the parallel wire guide.
- b Washers may be used with the screws if guide wires are inserted in non-adjacent holes of the wire guide.
- c Placing the guide wires through adjacent holes will allow clearance for screws but not for washers.

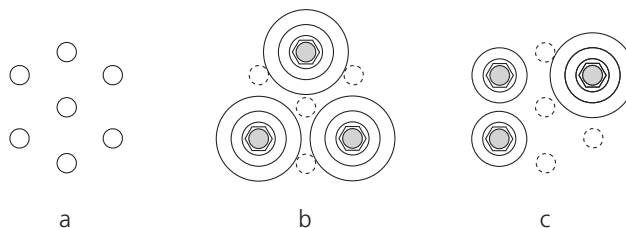

4

Insert guide wires and screws

Insert the desired number of guide wires 5–10 mm below articular cartilage and remove the wire guide. Determine the screw lengths and insert screws.

See steps 1–6, pages 6–11, for a precise description.

Implant removal

Expose the screw head and remove the screws using the special screwdriver for the removal of cannulated screws.

Warning

Do not use the cannulated screwdriver for implant removal.

Required instruments

Cannulated Screw	Screwdriver	Screwdriver Shaft and Handle
3.0	–	Cruciform Screwdriver Shaft (314.465) and Handle with Quick Coupling (311.430)
3.5	–	Hexagonal Screwdriver Shaft (314.030) and Handle with Quick Coupling (311.430)
4.0	–	Hexagonal Screwdriver Shaft (314.030) and Handle with Quick Coupling (311.430)
4.5	–	Hexagonal Screwdriver Shaft (314.150) and T-Handle with Quick Coupling (311.440)
7.0	Hexagonal Screwdriver (314.270)	–
6.5/7.3	Hexagonal Screwdriver (313.930)	Hexagonal Screwdriver Shaft (314.040) and Quick Coupling (338.490) or Universal Chuck with T-Handle (393.100)

Instrument cleaning

Clean the cannulated instruments thoroughly after each use. This helps maintain the correct operation of the instruments.

The instrument cannulations can be cleaned during operations using the cleaning stylet.

The instrument cannulations can be cleaned postoperatively using the cleaning stylet and cleaning brush.

For detailed information on the cleaning of instruments please refer to the cleaning manual "Care and Maintenance of Synthes Instruments" (Art. No. 015.000.090) and the chapter "Care and maintenance of AO/ASIF instrumentation" in Texhammar R, Colton C (1994) AO Instruments and Implants, Berlin, Springer: 394–433.

Required instruments

Cannulated Screw	Cleaning Stylet	Cleaning Brush
3.0	Ø 1.1 mm (319.292)	Ø 1.25 mm (319.291)
3.5	Ø 1.25 mm (319.380)	Ø 1.35 mm (319.250)
4.0	Ø 1.25 mm (319.380)	Ø 1.35 mm (319.250)
4.5	Ø 1.6 mm (319.350)	Ø 1.75 mm (319.260)
7.0	Ø 2.0 mm (319.360)	Ø 2.1 mm (319.270)
6.5/7.3	Ø 2.8 mm (319.460)	Ø 2.9 mm (319.240)



Manufacturer: Stratec Medical
Eimattstrasse 3, CH-4436 Oberdorf
www.synthes.com

Presented by:

