



# TRIGEN<sup>◇</sup>

## Hindfoot Fusion Nail Surgical Technique

### **As described by:**

Thomas A. Russell, MD

Roy W. Sanders, MD

John S. Early, MD

### **Contents**

Design Rationale.....	3
Indications .....	3
Design Features .....	4
Design Specifications .....	5
Surgical Technique .....	6
Catalog Information .....	19

### **Nota Bene**

The technique description herein is made available to the healthcare professional to illustrate the author's suggested treatment for the uncomplicated procedure. In the final analysis, the preferred treatment is that which addresses the needs of the specific patient.

## Uncover an easier and more advanced nailing system

The TRIGEN® Hindfoot Fusion Nail (HFN) offers unique locking configurations allowing the surgeon to target the best bone possible within the hindfoot to maximize purchase and position. As an addition to the already successful TRIGEN Intramedullary Nail System, the TRIGEN HFN uses the simplified instrumentation that has made TRIGEN a standout among other systems.



# Design Rationale

The TRIGEN® Hindfoot Fusion Nail (HFN) brings the simplified instrumentation of the TRIGEN Nail System to the hindfoot. Until now, surgeons have been limited to only medial-lateral and posterior anterior locking options. But now, the TRIGEN HFN takes locking a step further with an oblique locking configuration that allows surgeons to maximize thread purchase by locking into better bone. The TRIGEN HFN advantage allows surgeons to target screws through the calcaneus and into specific bones to attain the most stable construct while at the same time gaining fusion between the calcaneus and surrounding bones. Fusion is further aided by allowing screws to cross the articulating surfaces of the calcaneus and talus, as well as the calcaneus and cuboid bones.

Unlike other ankle arthrodesis nails that are currently available in the market, the TRIGEN HFN offers threaded distal screw holes for added stability and reduced risk of screw back out. In addition, the surgeon may select not to use specific holes or to use shorter screws that allow the joints to maintain mobility. Rotational stability is also achieved by either a proximal static locking hole or dynamic compression slot in the proximal end of the nail. The region of the nail near the driven end (inferior when implanted) has an increased outer diameter for additional rigidity and stability.

## Indications

The TRIGEN HFN is indicated for degeneration, deformity, or trauma of both the tibiotalar and talocalcaneal articulations in the hindfoot; tibiocalcaneal arthrodesis; combined arthrodesis of the ankle and subtalar joints; avascular necrosis of the ankle and subtalar joints; failed total ankle replacement with subtalar intrusion; failed ankle arthrodesis with insufficient talar body; rheumatoid arthritis; severe deformity secondary to untreated talipes equinovarus or neuromuscular disease; and severe pilon fractures with trauma to the subtalar joints.



# Design Features

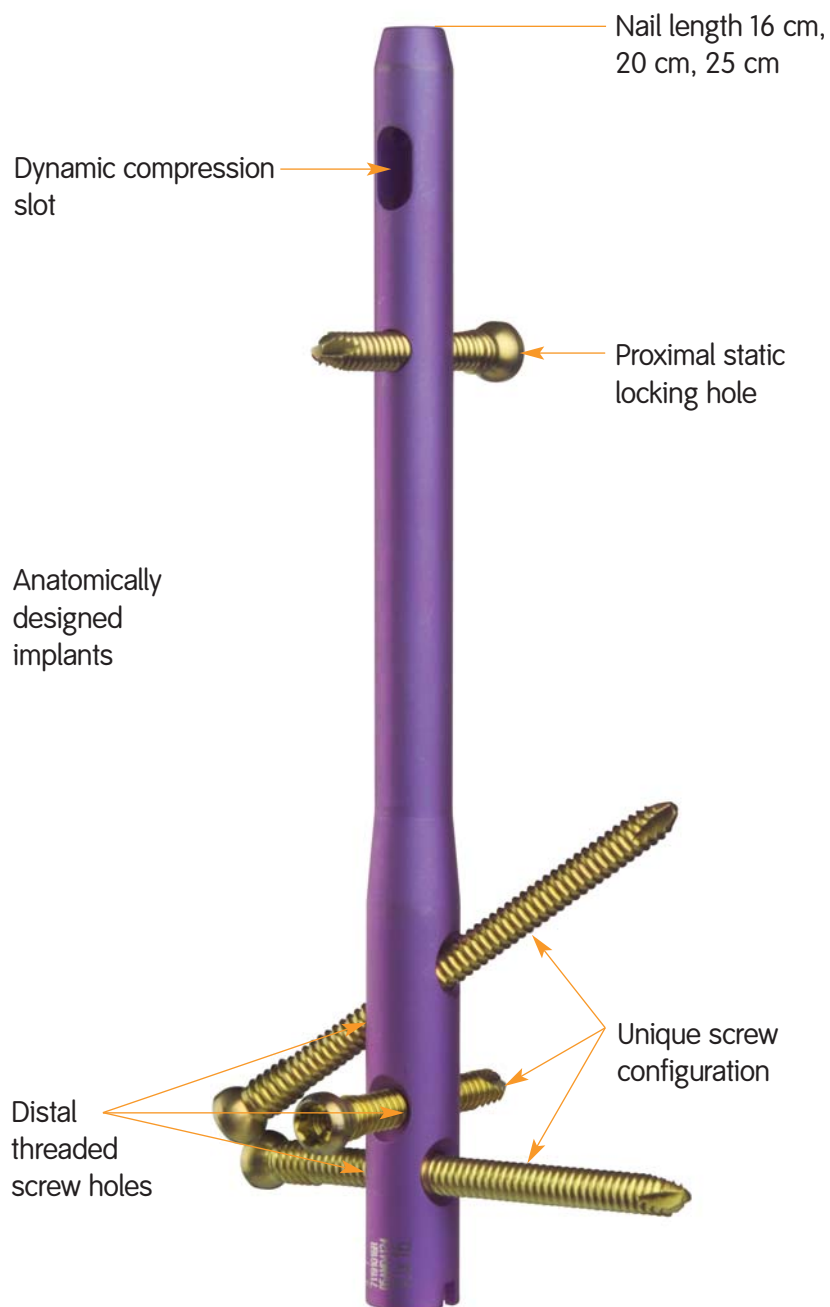

## Advantages

- Simplified instrumentation and anatomically designed implants included as part of the TRIGEN® line
- Diverging screw angles allow the surgeon to target specific bones and joints
- Distal threaded screw holes help to reduce risk of screw back out while adding stability
- Various screw sizes give the surgeon more options for patient care
- Rotational stability achieved with proximal static locking hole or dynamic compression slot
- Dynamic compression slot allows up to 5 mm of late controlled compression
- Internal hex captured locking screws help to ease screw insertion

# Design Specifications

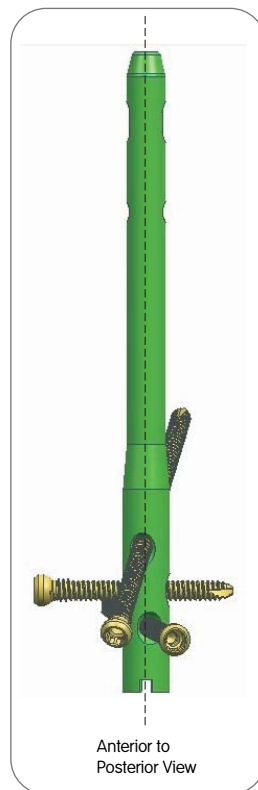
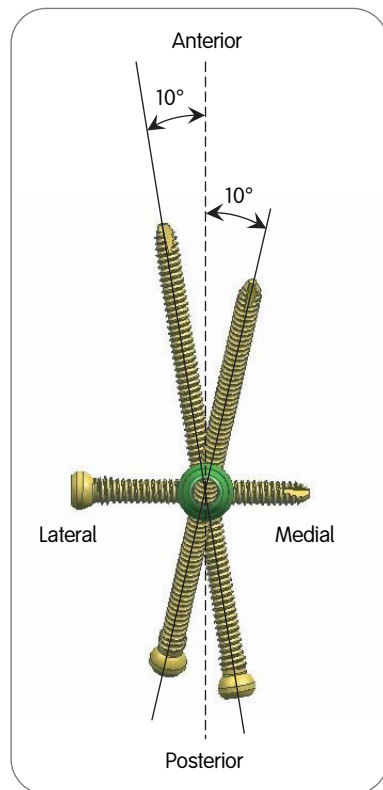
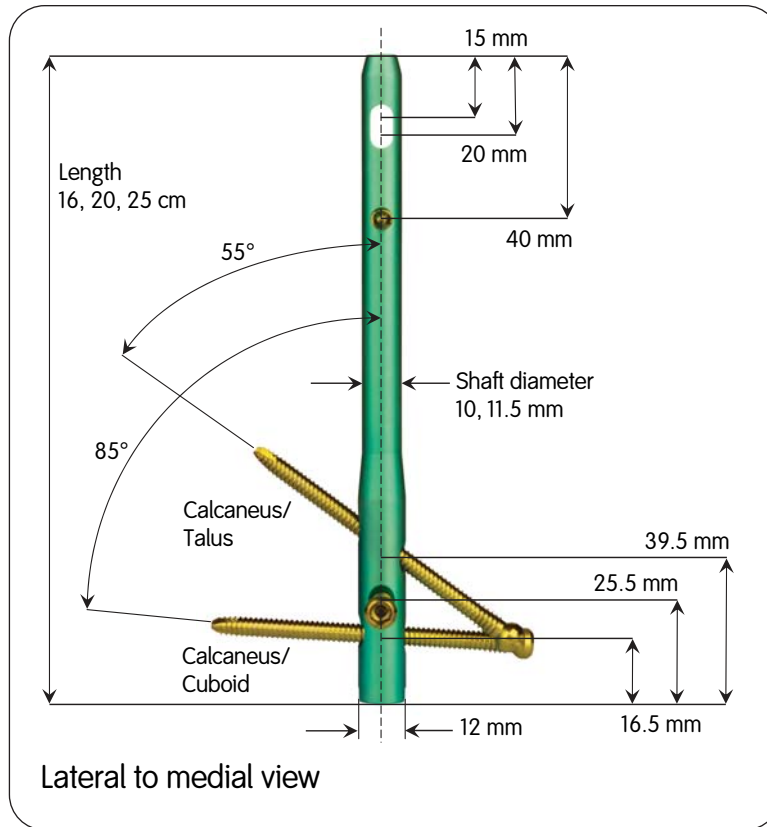

NOTE: These views are not to scale and should be used as a pictorial representation only.

Specifications	TRIGEN® HFN
Material	Ti6AL4V
Diameter	10.0, 11.5 mm
Lengths	16, 20, 25 cm
Nail color	Left - Lime Right - Rose
Cross Section	Round
Proximal Diameter (driving end)	12 mm
Proximal Diameter (non-driving end)	10.0 and 11.5 mm
Smallest Thru Diameter	5.4 mm
Wall Thickness	4.6 mm (10 Dia), 6.096 mm (11.5 Dia)
Guide Bolt Thread	5/16 - 24
Alternative Guide Bolts	RT Tibial, Retrograde, IMSC, Revision
Alternative Modes	No
Major Screw Diameter	5.0 mm
Minor Screw Diameter	4.3 mm
Hex Size	4.7 mm
Alternative Hex Drivers	RT Femoral & Recon, 7.0 mm Cannulated Screw, PERI-LOC® Locking Screw Guide
Screw Color	Gold
Screw Lengths	25-110 mm
AP Bow	No bow
Location of Distal Bend	No bow
<b>Distal Locking (Driving End)</b>	
Location	16.5, 25.5, 39.5 mm
Distal Dynamization Slot	none
Distal Screw Hole Diameter	5.3 mm
Orientation	Calcaneus/Talus P-A oriented and 55 degrees from nail axis in M-L plane, and 10 degrees off axis in sagittal plane.  Calcaneus/Cuboid P-A oriented and 85 degrees from nail axis in M-L plane, and 10 degrees off axis in sagittal plane.  Transverse L-M oriented with no angulation.
<b>Proximal Locking (Non-Driving End)</b>	
Proximal Screw Hole Diameter	5.3 mm
Screw Hole Locations	15-20 mm, 40 mm
Orientation	M-L
Proximal Dynamization Slot	Yes

# Surgical Technique

## Preoperative Planning

The appropriate TRIGEN® HFN implant length and diameter can be determined using the preoperative X-ray template.

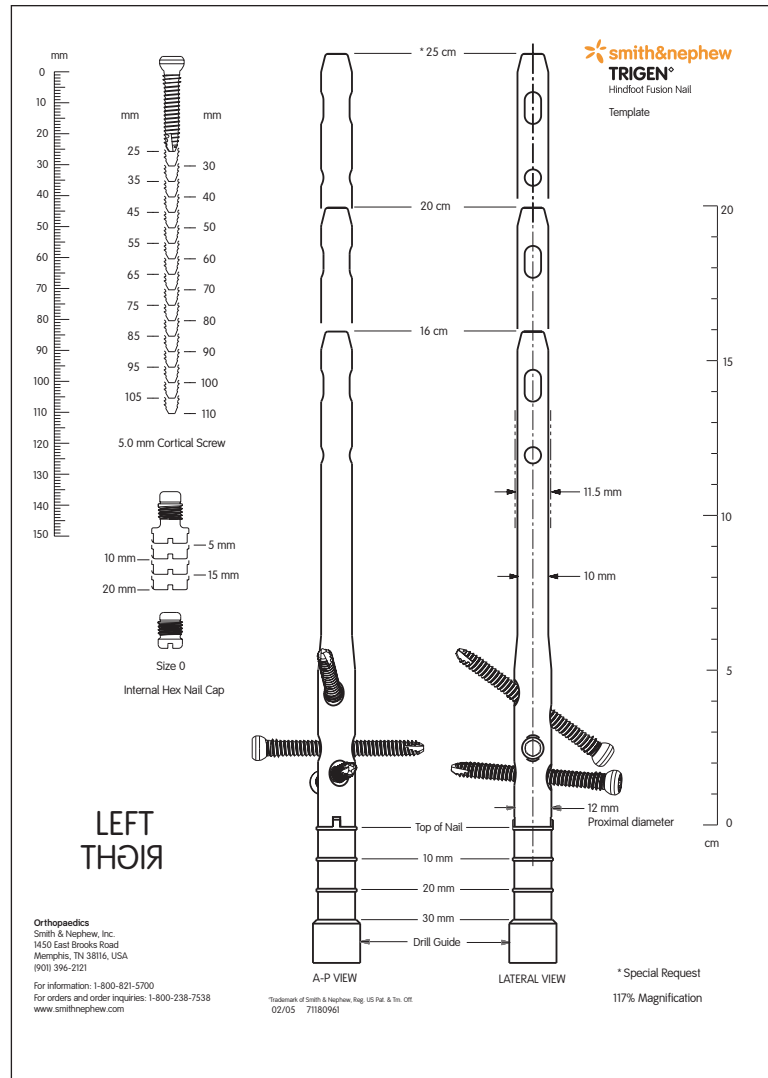

TRIGEN HFN X-ray Template

Cat. No. 7118-0961

### Patient Positioning

The prone position is preferred, but lateral and supine positions are acceptable if needed. Patient positioning is determined based on the type of arthrodesis procedure performed and is therefore at the surgeon's discretion.

### C-Arm Position

The C-arm should come in perpendicular to the leg, on the opposite side of the operating table. In the standard position this will provide an AP (supine), PA (prone), or lateral (lateral) radiograph. Turning the C-arm 90 degrees will afford a lateral view for the supine and prone positions while providing an AP view for the patient in the lateral position.

Note: For optimal viewing, the operating table should be radio translucent.

### Surgical Approach

The approach chosen for the debridement, preparation and alignment of the hindfoot joint surfaces is based on factors such as surgical preference, patient positioning, and anatomy. The simplest approach is usually through a lateral incision over the fibula and into the sinus tarsi. Full access to the joint surfaces requires a fibular osteotomy above the tibiotalar joint. This allows direct visualization and access to both the tibiotalar and sub-talar joints for debridement and subsequent alignment for fixation. This approach can be extended distally if access to the calcaneocuboid joint is needed.

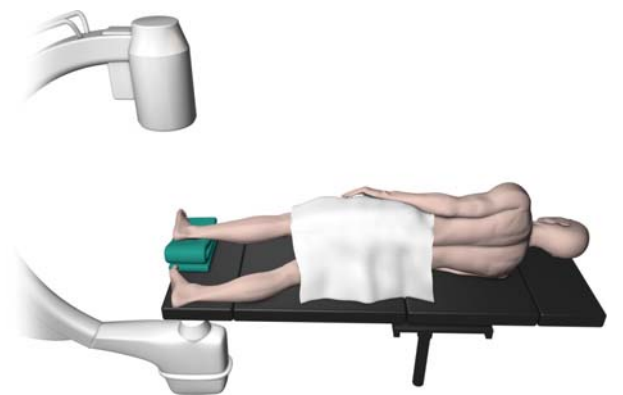
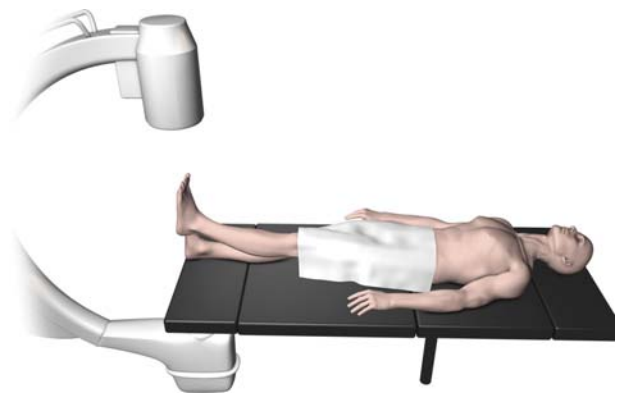
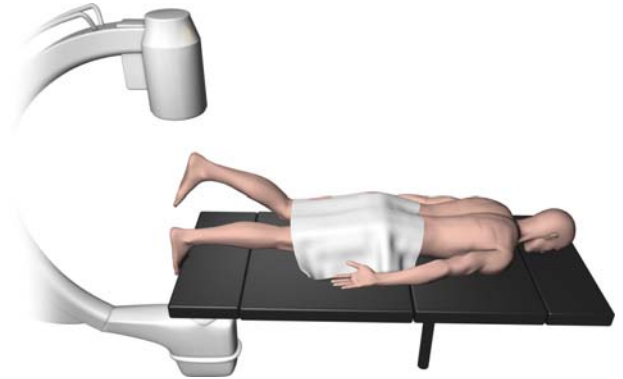



## Entry Portal

Once all the joint surfaces have been prepared and aligned in the desired position of fusion, the C-arm is brought into position laterally, and the 3.2 mm x 343 mm Tip Threaded Guide Pin is placed on the plantar surface of the foot in line with the tibia, talus, and calcaneus. The use of provisional guide pin fixation to maintain correct position of the respective arthrodesis is recommended. The Guide Pin will start slightly lateral to midline, in line with the tibial medullary canal axis.



Using this as the center of the planned insertion point, a 3 cm longitudinal incision is made on the plantar aspect of the heel.

A hemostat is used to bluntly spread the soft tissues and open the plantar fascia down to bone. Assemble and place the Entry Tool through the incision to bone.

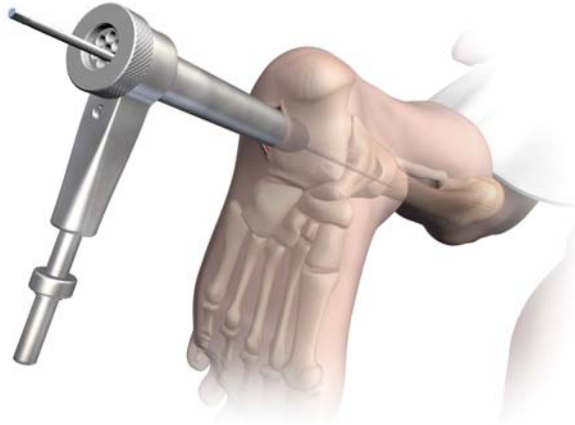

---

3.2 mm x 343 mm  
Tip Threaded Guide  
Pin

Cat. no. 7167-4029



Entry Tool  
Cat. no. 7163-1114

## Guide Pin Placement

With the hindfoot in the position of desired fusion, the Guide Pin is powered in from the calcaneus to the tibia under fluoroscopic control. The C-arm is rotated into the AP/PA position to verify that the Guide Pin is positioned centrally within the tibia. If initial guide pin placement is not optimal, a second guide pin may be placed through the Entry Tool to ensure proper alignment.

Note: Any deviation from a central position can affect the final fusion position. With the Guide Pin along the anterior tibia, the nail will increase dorsiflexion and anterior position of the foot. However, along the posterior cortex, the Guide Pin will have the opposite effect. The Guide Pin contact with the medial or lateral walls of the tibia can cause increased varus or valgus position changes respectively in the foot.

Once the desired position is confirmed, advance the Guide Pin until it is 2-3 cm beyond the desired length of the nail to ensure adequate proximal reaming.



3.2 mm x 343 mm  
Tip Threaded Guide  
Pin

Cat. no. 7167-4029

Entry Tool  
Cat. no. 7163-1114

## Reaming

Using the 12.5 mm Entry Reamer, ream into the tibia, ideally stopping at the threads on the Guide Pin. This should ensure adequate reaming of the canal beyond the chosen length of the nail and allow room for impaction and compression of the construct without binding the nail proximally.

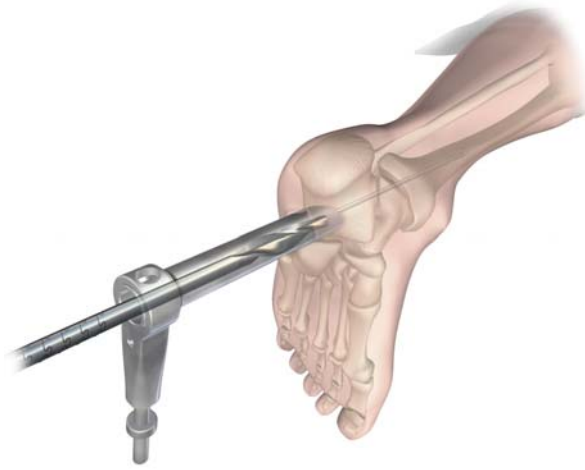

Additional reaming depth may be required if proximal dynamic locking is desired. Formal canal preparation using sequential reamers will be needed if reaming depth cannot be obtained with the Entry Reamer.

Note: After canal reaming the Guide Pin will most likely be extracted with removal of the Entry Reamer.



3.2 mm x 343 mm  
Tip Threaded Guide  
Pin

Entry Tool  
Cat. no. 7163-1114

Cat. no. 7167-4029

## Reducing the Fracture

In most cases, the 3.0 mm x 600 mm Ball Tip Guide Rod can now be easily inserted through the initial portal made by the Entry Reamer and placed into the center of the tibia. If needed, the hindfoot position can be realigned using the Reducer attached to the T-Handle. Check to ensure the Guide Pin has been removed prior to inserting the Reducer. The Reducer is used to accurately place the Guide Rod in the tibia to assure proper reaming and nail insertion.

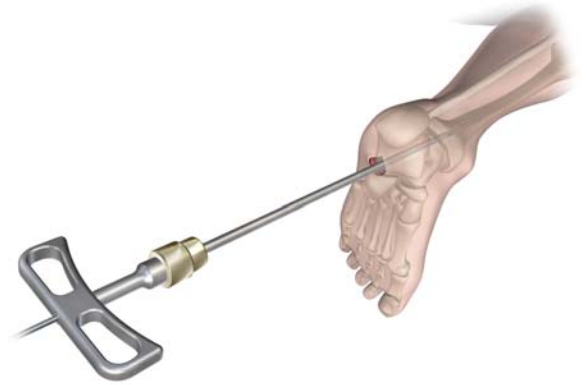

To maintain reduction, introduce the Guide Rod through the T-Handle and Reducer with the use of the Gripper. Once the Guide Rod is in place, remove the Reducer, using the Obturator as needed to ensure the Guide Rod stays in place.



---

3.0 mm x 600 mm  
Ball Tip Guide Rod  
Cat. no. 7166-5026

Reducer  
Cat. no. 7175-1105



T-Handle  
Cat. No. 7163-1172



Gripper  
Cat. No. 7163-1100



Obturator  
Cat. No. 7163-1122

## Nail Assembly and Insertion

Assemble the nail to the Drill Guide using the Guide Bolt and Guide Bolt Wrench. The nail is keyed and can only be assembled to the Drill Guide in the correct way.

Using hand force, insert the nail through the incision into the reamed canal and seat flush to the plantar surface of the calcaneus.



Note: Once proper entry depth is obtained, the Impactor may be attached to the Drill Guide. Initial manual compression may be achieved by flexing the knee and using the Slotted Hammer to tap the construct.

Position the C-arm to obtain an M-L view of the nail's driving end. Maintain the foot in the anatomical position and rotate the nail until the transverse hole can be visualized as a perfect circle. Under fluoroscopy, use the shadows of the cuboid and talus screw holes as alignment guides for screw placement.

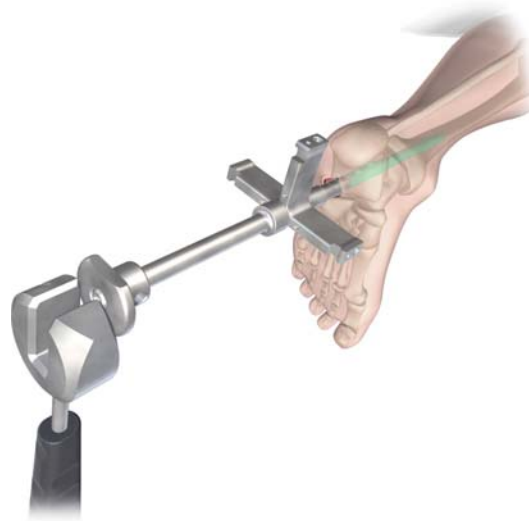

Once proper alignment is established, the orientation can be fixed using a guide pin(s) through the provisional fixation holes in the Drill Guide.

Remove the Guide Rod prior to fully seating the nail.

Note: The Guide Rod will not pass through the Impactor.

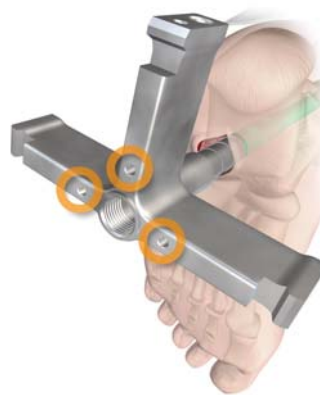

HFN Nail  
Cat. No. 7170-XXXX

Drill Guide  
Cat. No. 7170-0005

Guide Bolt  
Cat. No. 7163-1136

Guide Bolt Wrench  
Cat. No. 7163-1140

Impactor  
Cat. No. 7166-5020

Slotted Hammer  
Cat. No. 7163-1150

## Screw Insertion

Although screw placement sequence is at the surgeon's discretion, it is recommended that the locking screws be placed sequentially from calcaneus to tibia to allow impaction at each joint level.

Attach the Drop to the posterior side of the Drill Guide. Place the 4.0 mm Silver Inner Drill Sleeve into the Gold Outer Drill Sleeve and insert the sleeve assembly through the Drop's cuboid hole. The sleeve assembly end should sit on the lateral side of the calcaneal tuberosity and not on the lateral face of the calcaneus. Rotate the nail assembly if needed to keep the screws on the posterior surface. Make a stab incision to allow the sleeves to contact bone.

Note: For added stability and rotational control, advance the Long Pilot Drill through the drill sleeve assembly to the desired depth. Remove the Long Pilot Drill from power, leaving it in the cuboid hole as a provisional fixation tool for the talus screw insertion.

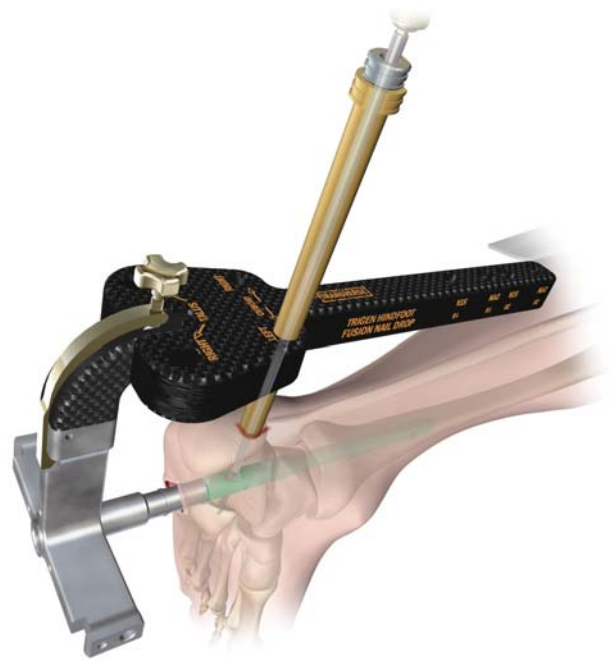

Drop  
Cat. No. 7170-0004



4.0 mm Silver Inner  
Drill Sleeve  
Cat. No. 7163-1156



9 mm Gold Outer  
Drill Sleeve  
Cat. No. 7163-1152

## Talus Screw Insertion

Screw length is determined from the calibrated markings on the Long Pilot Drill or by using the Screw Depth Gauge.

The talus screw should be inserted from posterior-inferior and lateral in the calcaneus to anterior-medial in the talar dome. This screw will sit approximately perpendicular to the subtalar joint.

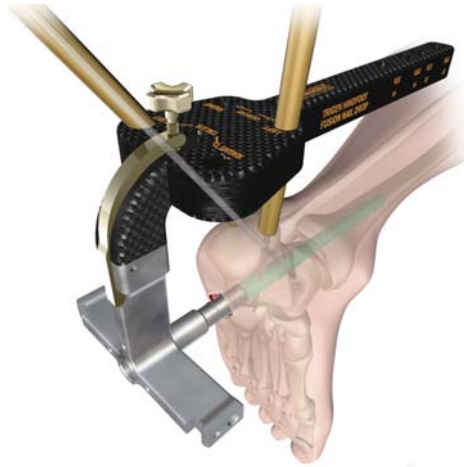

Advance the Long Pilot Drill. Remove the Long Pilot Drill and the Silver Inner Drill Sleeve. Attach the 5.0 mm screw to the Medium Hex Driver. Attach the Medium Hex Driver to power or use the manual T-Handle to insert the screw. Insert the screw assembly through the Gold Outer Drill Sleeve.

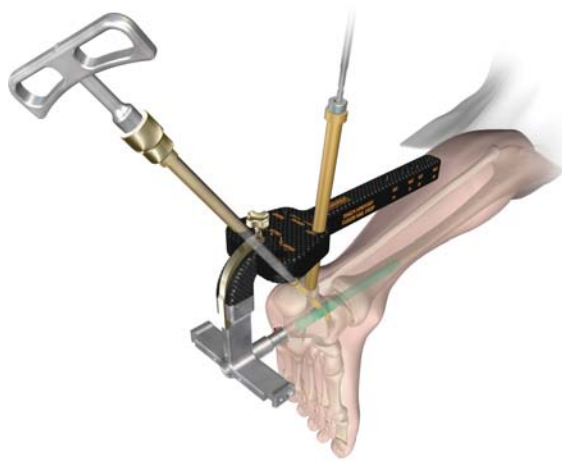

When using power, stop advancing the screw when the laser marked ring on the Medium Hex Driver approaches the top of the Gold Outer Drill Sleeve. It is recommended that final tightening of the screw should always be under manual control.

Note: Sinking the distal screw heads into the calcaneus helps prevent soft tissue irritation.

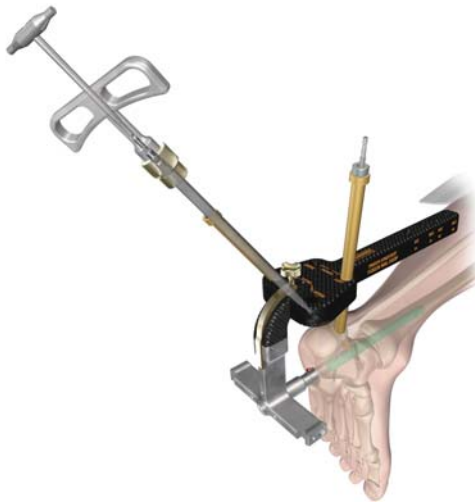

The Screw Driver Release Handle may be used to detach the Medium Hex Driver from the screw. Once the talus screw is placed, the tibiotalar joint can be manually compressed and aligned by attaching the Impactor to the Drill Guide and the using Slotted Hammer to tap the construct.

4.0 mm Long Pilot Drill  
Cat. No. 7163-1110

Screw Depth Gauge  
Cat. No. 7163-1189

5.0 mm Internal Hex  
Captured Locking  
Screw  
Cat. No. 7164-22XX

Medium Hex Driver  
Cat. No. 7163-1066

Screw Driver  
Release Handle  
Cat. No. 7163-1208

T-Handle  
Cat. No. 7163-1172



### Cuboid Screw Insertion

Repeat this procedure for the cuboid screw which should be oriented posterior-medial in the calcaneus to anterior-lateral in the cuboid.

Advance the Long Pilot Drill through to the anterior process of the calcaneus. If cuboid fixation is desired, continue advancing the Long Pilot Drill through to the distal aspect of the cuboid.

### Transverse Screw Insertion

Once these screws are in place, a third transverse distal locking option can be used at the surgeon's discretion.

Remove the Drop and attach it on the lateral aspect of the Drill Guide. Markings on the Drill Guide will help ensure proper orientation.

Insert the drill sleeve assembly into the transverse hole on the Drop and repeat the above procedure.

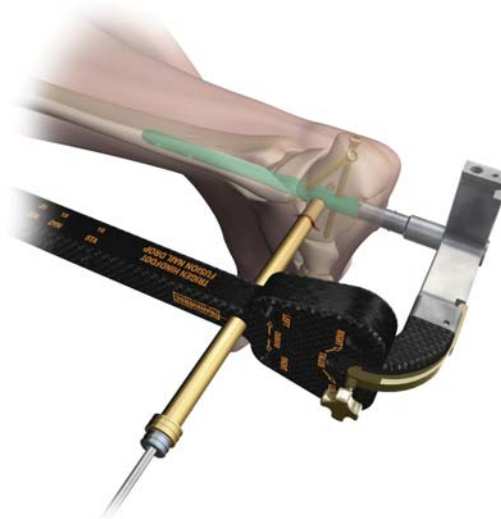

4.0 mm Long Pilot Drill  
Cat. No. 7163-1110

Screw Depth Gauge  
Cat. No. 7163-1189



5.0 mm Internal Hex  
Captured Locking  
Screw  
Cat. No. 7164-22XX



Medium Hex Driver  
Cat. No. 7163-1066



Screw Driver  
Release Handle  
Cat. No. 7163-1208



T-Handle  
Cat. No. 7163-1172



## Proximal Locking Screw Insertion

To lock the nail proximally, remove the Drop and attach it on the medial aspect of the Drill Guide. Markings on the Drill Guide will help ensure proper Drop orientation.

Dynamic or static proximal locking options are available to the surgeon. Both options provide a locking screw to prevent rotation of the implant. The dynamic option allows for up to 5 mm of late settling of the nail. If this option is chosen it is important to ream beyond the desired nail length to minimize binding. Markings on the Drop dictate the proximal static or dynamic locking options available.

Note: The 25 cm nail can not be targeted proximally and must be done freehand. The same screw drilling and insertion procedure used distally is then repeated.

When presented with hard cortical bone, the 4.7 mm Diaphyseal Starter Drill can be used to perforate the near cortex.

Note: The Silver Inner Drill Sleeve must be removed from the Gold Outer Sleeve prior to using the Diaphyseal Drill. The Gold Outer Drill Sleeve must be touching bone as the Diaphyseal Drill will bottom out on the Gold Outer Drill Sleeve.

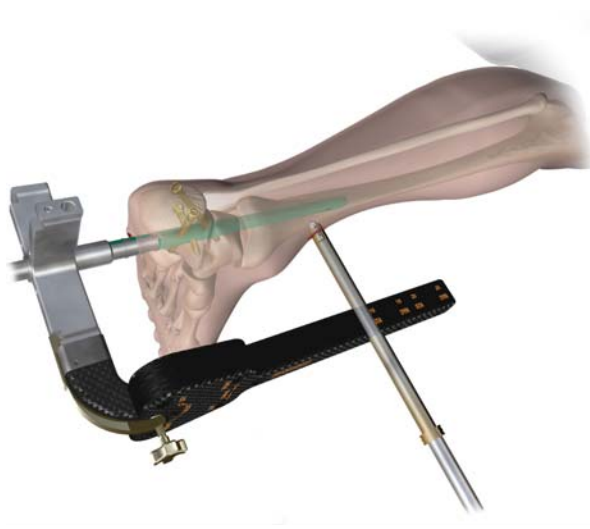

---

4.7 mm Diaphyseal  
Starter Drill  
Cat. no. 7170-0006

## Implantation Complete

Note: Bone graft or bone graft substitutes should be used to fill in gaps around the bones to enhance bony union.

Follow standardized procedures for closure.

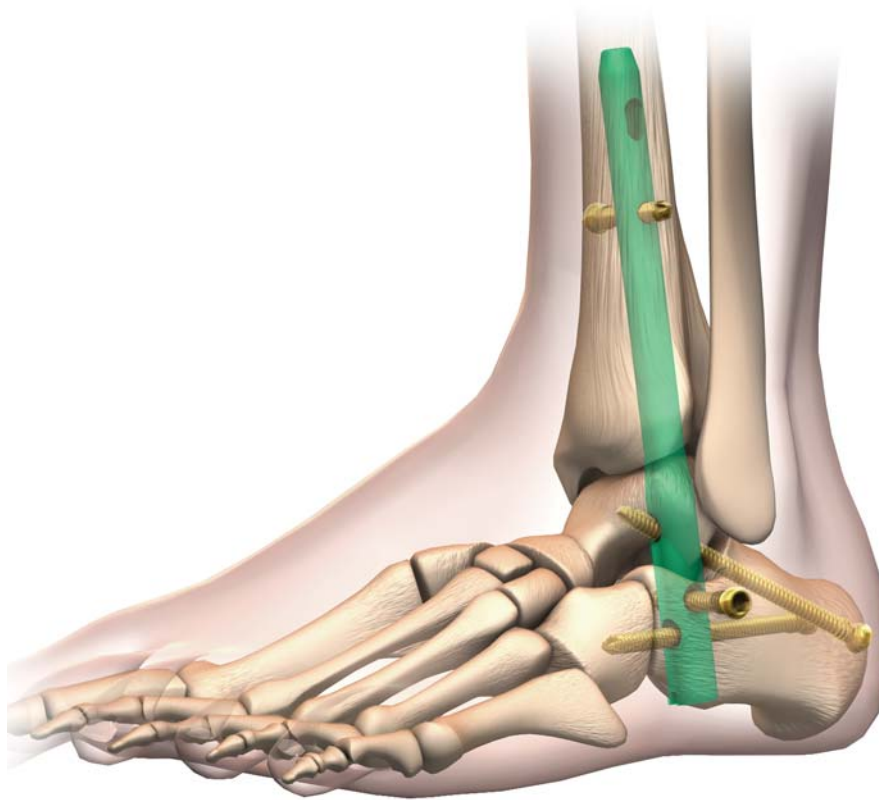

VIAGRAF®  
Demineralized Bone  
Matrix – Crunch  
Cat. no. 71791x



VIAGRAF  
Demineralized Bone  
Matrix – Flex  
Cat. no. 71991x



VIAGRAF  
Demineralized Bone  
Matrix – Gel  
Cat. no. 71791x



VIAGRAF  
Demineralized Bone  
Matrix – Paste  
Cat. no. 71790x



VIAGRAF  
Demineralized Bone  
Matrix – Putty  
Cat. no. 71790x

VIAGRAF  
Demineralized Bone  
Matrix – Cancellous  
Chips  
Cat. no. 71792x

## Nail Removal

It is not recommended to remove the nail unless deep infection occurs or if the patient is symptomatic.

However if removal is required, then dissect the plantar soft tissue to expose the distal end of the nail. Clear away any tissue or bone that may have grown into the threads in the end of the nail. Thread the Large Nail Extractor tool into the distal end of the nail before screw removal to restrict nail movement. The Impactor may also be threaded into the Large Nail Extractor to aid in the nail extraction.

Make stab wounds over the original incisions and remove the screws with the Medium Hex Driver and T-Handle.

Once all the screws have been removed, extract the nail from the foot. The Slotted Hammer may be used with the Impactor to aid in removal.

Close in the usual manner.

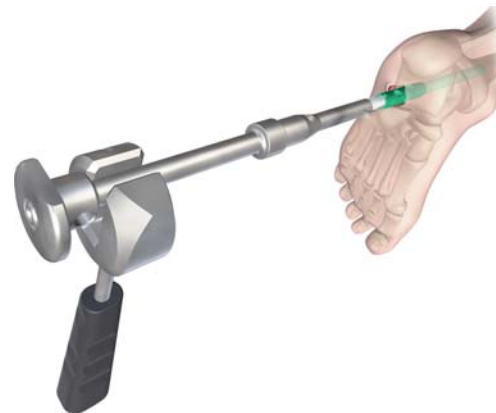
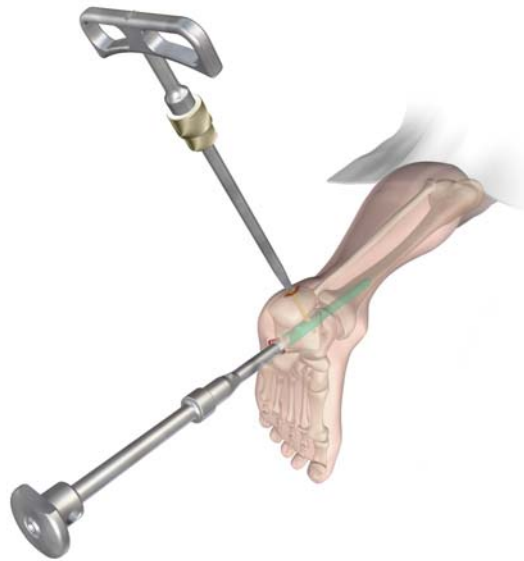
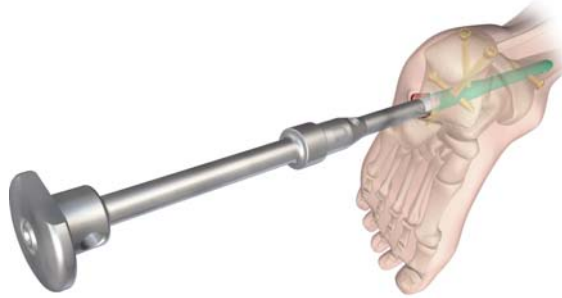

Large Nail Extractor  
Cat. no. 7163-1278

# Catalog Information – Implants (Set No. 7170-0000)

## 5.0 mm Internal Hex Captured Locking Screws



Cat. No.	Length
7164-2225	25 mm
7164-2230	30 mm
7164-2235	35 mm
7164-2240	40 mm
7164-2245	45 mm
7164-2250	50 mm
7164-2255	55 mm
7164-2260	60 mm
7164-2265	65 mm
7164-2270	70 mm
7164-2275	75 mm
7164-2280	80 mm
7164-2285	85 mm
7164-2290	90 mm
7164-2295	95 mm
7164-2200	100 mm
7164-2205	105 mm
7164-2210	110 mm

## TRIGEN® Hindfoot Fusion Nails – 10 mm

Cat. No.	Description
7170-1016L	10 mm x 16 cm Left
7170-1016R	10 mm x 16 cm Right
7170-1020L	10 mm x 20 cm Left
7170-1020R	10 mm x 20 cm Right
7170-1025L	10 mm x 25 cm Left
7170-1025R	10 mm x 25 cm Right



## TRIGEN Hindfoot Fusion Nails – 11.5 mm

Cat. No.	Description
7170-1116L	11.5 mm x 16 cm Left
7170-1116R	11.5 mm x 16 cm Right
7170-1120L	11.5 mm x 20 cm Left
7170-1120R	11.5 mm x 20 cm Right
7170-1125L	11.5 mm x 25 cm Left
7170-1125R	11.5 mm x 25 cm Right



# Catalog Information – Instruments (Set No. 7170-0001)

## Screw Length Sleeve

Cat. No. 110238



## SCULPTOR® Flexible Shaft with Circular Connector

Cat. No. 7111-8200



## Medium TRIGEN® Hexdriver

Cat. No. 7163-1066



## Short TRIGEN Hexdriver

Cat. No. 7163-1068



## Gripper

Cat. No. 7163-1100



## Entry Tool

Cat. No. 7163-1114



## 12.5 mm Entry Reamer

Cat. No. 7163-1116



## Obturator

Cat. No. 7163-1122



## Guide Bolt

Cat. No. 7163-1136



## Guide Bolt Wrench

Cat. No. 7163-1140



# Catalog Information – Instruments (Set No. 7170-0001)

## Hammer

Cat. No. 7163-1150



## 9 mm Gold Outer Drill Sleeve

Cat. No. 7163-1152



## 4.0 mm Silver Inner Drill Sleeve

Cat. No. 7163-1156



## T-Handle (Zimmer-Hall)

Cat. No. 7163-1172



## Mini Connector

Cat. No. 7163-1186



## Mini Connector with Trinkle End

Cat. No. 7163-1187



## Screw Depth Gauge

Cat. No. 7163-1189



## Screw Driver Release Handle

Cat. No. 7163-1208



## Large Nail Extractor

Cat. No. 7163-1278



## Impactor

Cat. No. 7166-5020



# Catalog Information – Instruments (Set No. 7170-0001)

## TRIGEN® Hindfoot Fusion Nail Drop

Cat. No. 7170-0004



## TRIGEN Hindfoot Fusion Nail Drill Guide

Cat. No. 7170-0005



## TRIGEN 4.7 mm Diaphyseal Starter Drill

Cat. No. 7170-0006



## Humeral Straight Reducer

Cat. No. 7175-1105



## AO Mini Connector

Cat. No. 7175-1153



## Modular Reamer Box Kit

Cat. No. 7163-1218



## Reamer Heads

Cat No.	Description
71118231	9.0 mm Endcutting
71118233	9.5 mm Pilot Nose
71118234	10.0 mm Pilot Nose
71118235	10.5 mm Pilot Nose
71118236	11.0 mm Pilot Nose
71118237	11.5 mm Pilot Nose
71118238	12.0 mm Pilot Nose



## Large Outer Case – 4.8”

Cat. No. 7112-9400



## Lid for Outer Case

Cat. No. 7112-9402



TRIGEN® Hindfoot Fusion Nail Top Instrument Tray  
(Not shown)  
Cat. No. 7170-0015

TRIGEN Hindfoot Fusion Nail Bottom Instrument Tray  
(Not shown)  
Cat. No. 7170-0016

## Catalog Information – Disposables (Set No. 7170-0012)

4.0 mm Long Pilot Drill  
Cat. No. 7163-1110



4.0 mm Short Drill  
Cat. No. 7163-1117



3.0 mm x 600 mm Ball Tip Guide Rod  
Cat. No. 7166-5026



3.2 mm x 343 mm Tip Threaded Guide Pin  
Cat. No. 7167-4029



## Catalog Information – Samples (Set No. 7170-0013)

TRIGEN Hindfoot Fusion Nail Sample Nail  
10 mm x 16 cm Left  
Cat. No. 7119-1016L



Internal Hex Locking Screw 5.0 mm x 35 mm  
Cat. No. 7119-2535



Internal Hex Locking Screw 5.0 mm x 70 mm  
Cat. No. 7119-2570



TRIGEN Hindfoot Fusion Nail Sample Case  
(Not shown)  
Cat. No. 7170-0014



# Catalog Information – VIAGRAF<sup>◇</sup> Demineralized Bone Matrix

## Crunch

Cat No.	Container
717914	5cc Jar
717915	15cc Jar



## Flex

Cat No.	Container
717917	5 x 2.5 cm Poly Bag
717918	10 x 2.5 cm Poly Bag
717919	5 x 5 cm Poly Bag



## Gel

Cat No.	Container
717910	1cc Syringe
717911	5cc Syringe
717912	10cc Syringe
717913	25cc Jar



## Paste

Cat No.	Container
717906	1cc Syringe
717907	5cc Syringe
717908	10cc Syringe



## Putty

Cat No.	Container
717902	1cc Jar
717904	5cc Jar
717905	10cc Jar



## Cancellous Chips

Cat No.	Container
717920	1.7-10 mm 15cc Tray
717921	1.7-10 mm 30cc Tray



**Orthopaedics**

Smith & Nephew, Inc.  
1450 Brooks Road  
Memphis, TN 38116  
USA

[www.smith-nephew.com](http://www.smith-nephew.com)

Telephone: 1-901-396-2121  
Information: 1-800-821-5700  
Orders/Inquiries: 1-800-238-7538